



EASY FAMILY

WHEN THE SENSOR IS COMPACT AND USER FRIENDLY, IT BECOMES INTELLIGENT. WHEN IT IS INTELLIGENT, YET OFFERS DURABILITY AND LOW MAINTENANCE COST, IT BECOMES THE PERFECT TOOL FOR THE RETAILERS OF TODAY.

FEATURES

- Built-in charging lead with alarm (Micro USB , USB-C, or Apple Lightning)
No need for secondary sensors
- Integrated lock-down feature
- Charging capability: 5V, 2A
- Non-charging version available
- Illuminated sensor
- 4Way positioning
- Claw - extra security

BENEFITS

- Simple tabletop installation
- 3 type of cradles: different height
- Cost-effective line-alarm solution
- Media-ready
- Easy remerchandising: simply unlock cable and change positions.



TSS - flat, low profile

- Line-alarm only
- Quick-release button
- Ideal for wall or table installations



TSM - angled

- Line-alarm only
- Quick-release button
- Works great with TSL (2 row installation)



TSL - attract more attention

- Line-alarm (LA) and Stand-alone (SA) version
- Adhesive and screw installation options
- Supports tablets
magnets keep it in place

iReader
(only Stand-alone version)



Symmetrical Claw - the perfect accessory

VISIT OUR WEBSITE FOR FURTHER INFO

- Single axis, easy add-on solution
- Suitable for phones and tablets
- Self-adjusting mechanism
- Crafted metal body, anti-slip paint cover

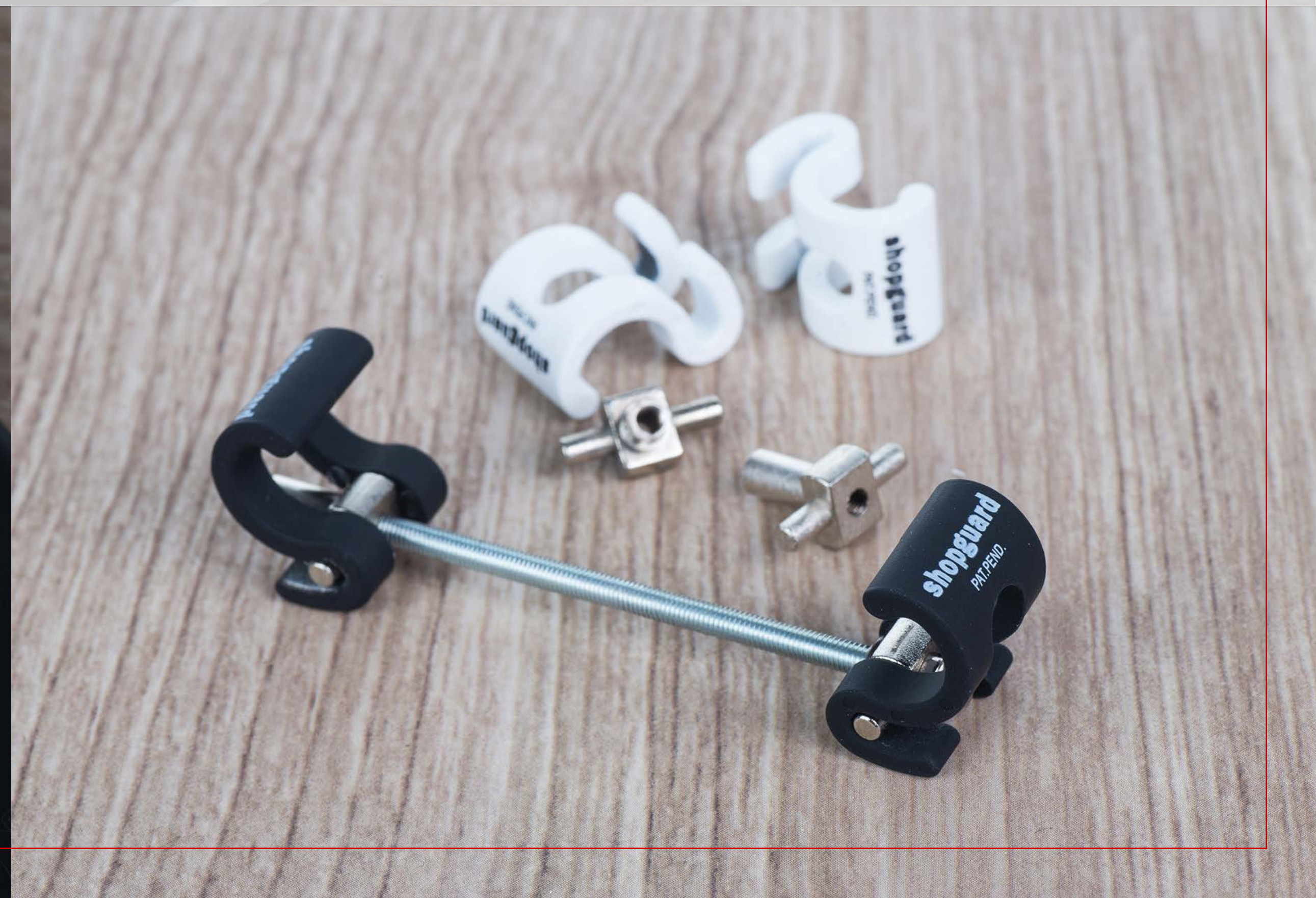

Connectivity

1-4 POSITIONS - M-4 CENTRAL UNIT

- Charging available
- External Reader

1. External reader
2. Positions (max 4)
3. PSU

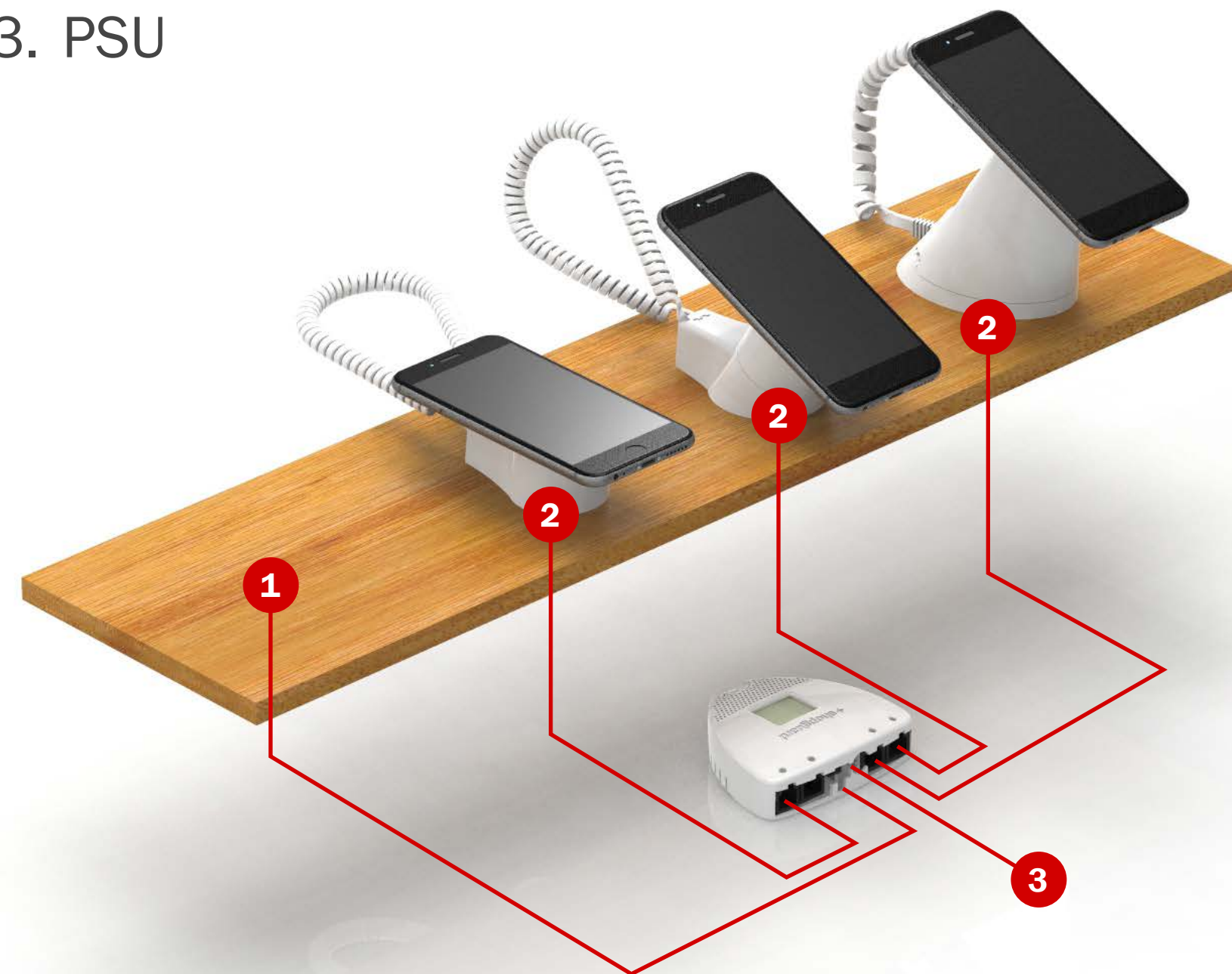

5-10 POSITIONS - M-10 CENTRAL UNIT

- Charging available
- External Reader and Buzzer (reader, buzzer, and illumination)
- Interactive features can be integrated (lift-up, data analytics)

1. External reader and buzzer
2. Positions (max 10)
3. PSU
4. Software port

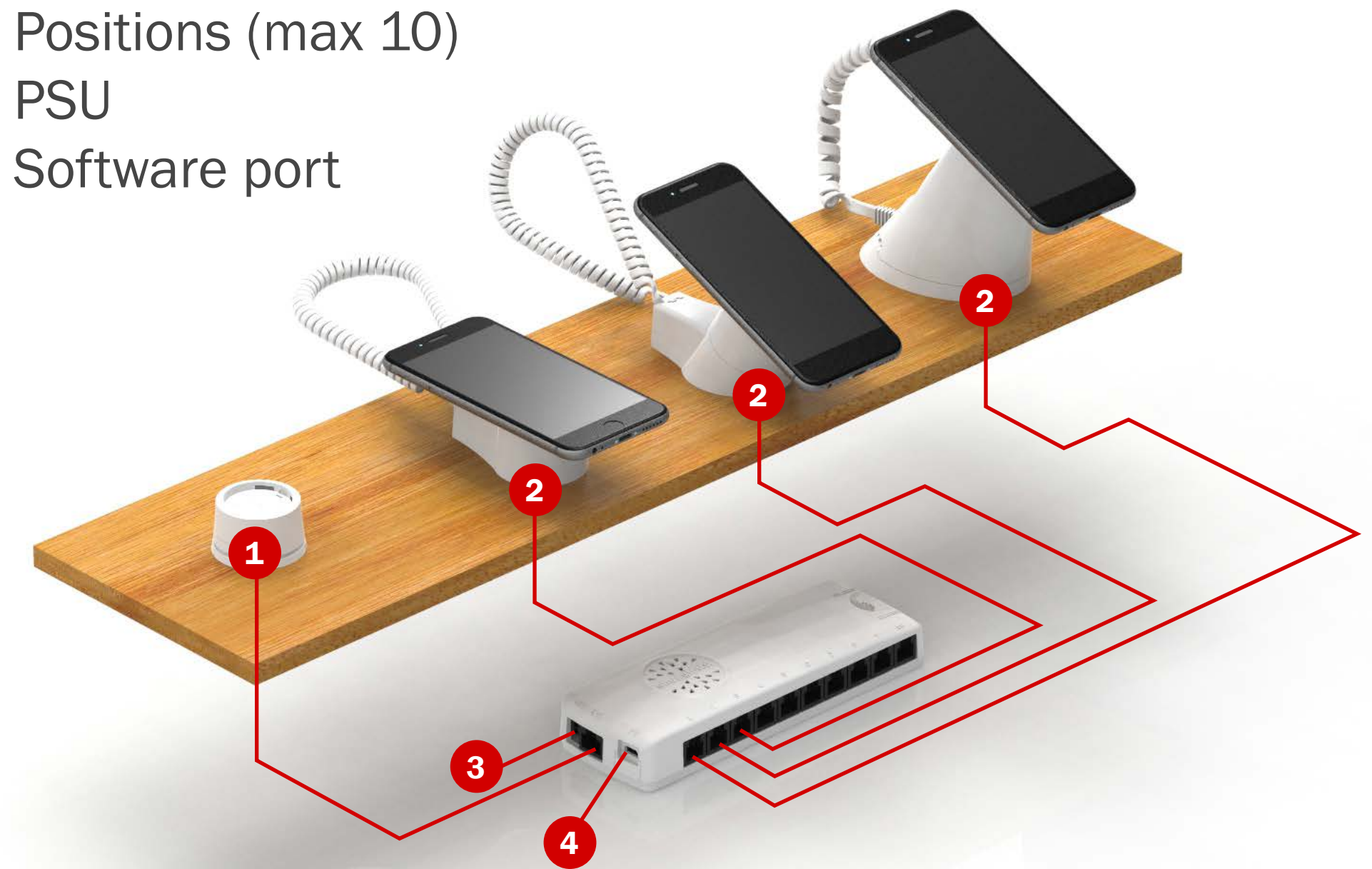

TSL - SA / LAQ COMPONENTS

TS Sensor adhesive
P0620085

TS Sensor
see next pages

Claw adapter
see next pages

Cable clip adhesive
part of sensor

Cable clip
part of sensor

Cradle
see next pages

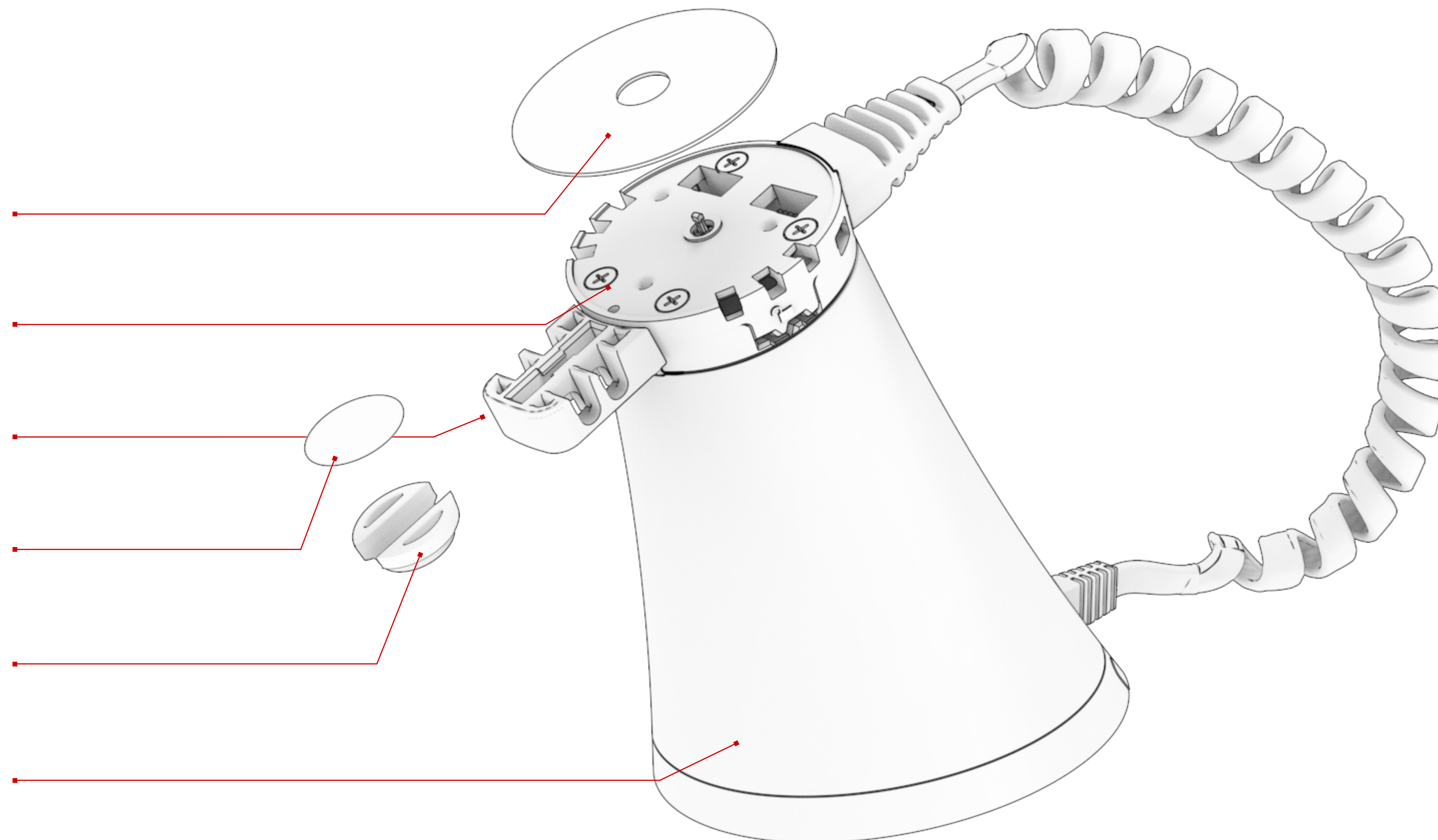

TSM COMPONENTS

TS Sensor adhesive
P0620085

TS Sensor
see next pages

Claw adapter
see next pages

Cable clip adhesive
part of sensor

Cable clip
part of sensor

Cradle
see next pages

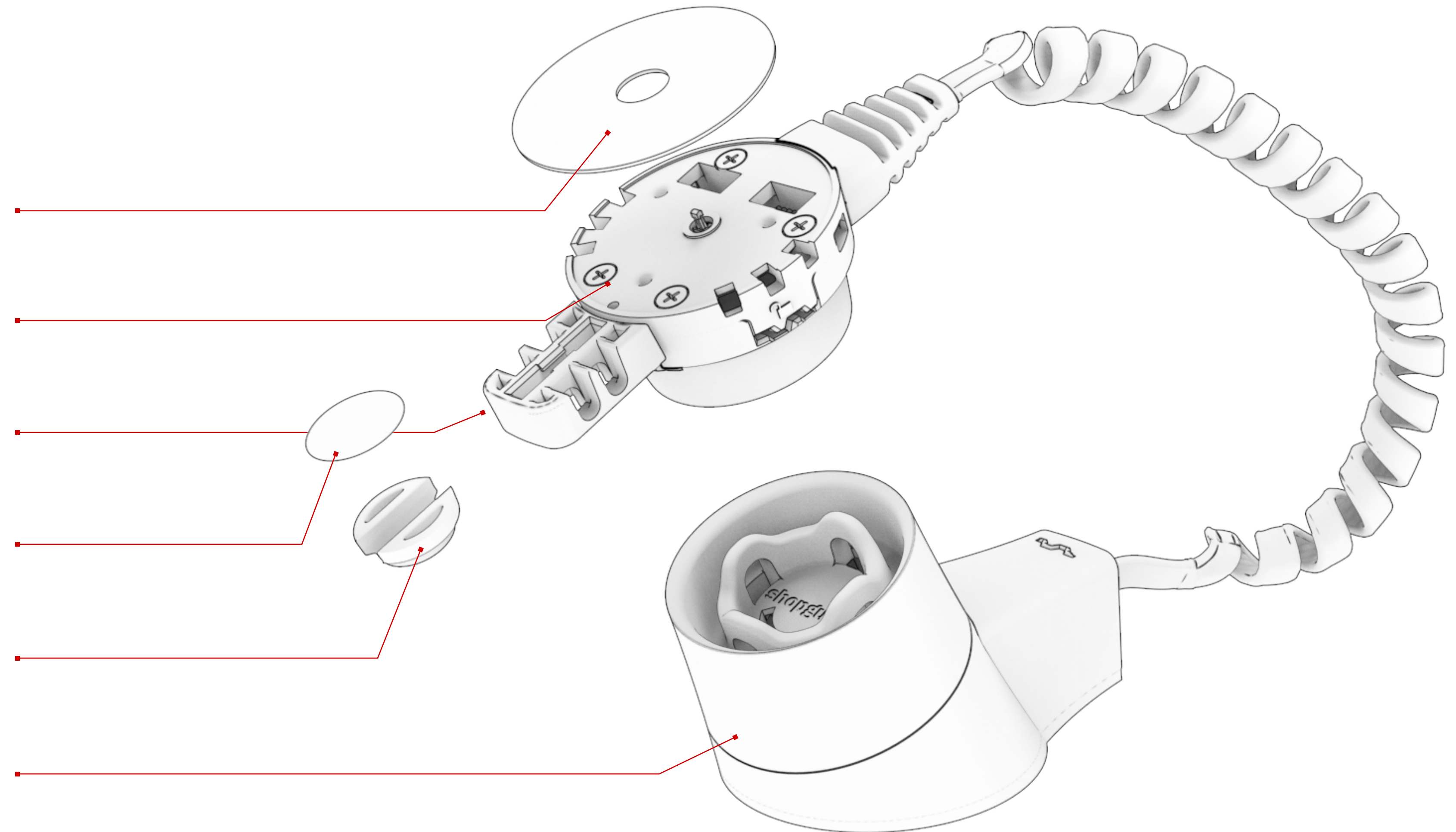

TSS COMPONENTS

TS Sensor adhesive
P0620085

TS Sensor
see next pages

Claw adapter
see next pages

Cable clip adhesive
part of sensor

Cable clip
part of sensor

Cradle
see next pages

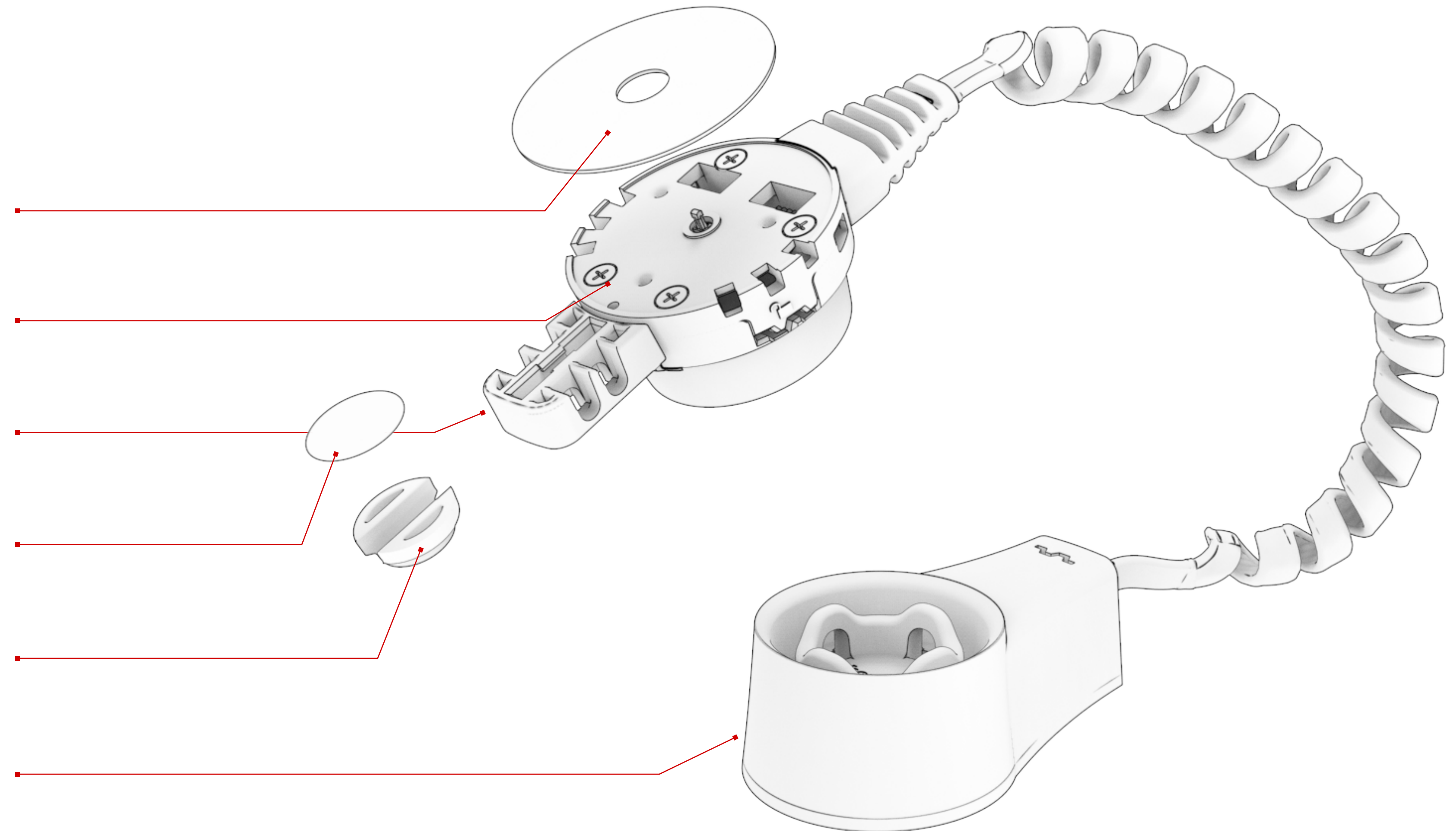

TSL (line-alarm)

Part # (white/black)	Description
P0603107 / P0603110	TSL LAQ line-alarm NON-CHARGING
P0603109 / P0603112	TSL LAQ line-alarm Apple MFi certified
P0603148 / P0603157	TSL LAQ line-alarm USB Type - C
P0603108 / P0603111	TSL LAQ line-alarm Micro USB

TSM (line-alarm)

Part # (white/black)	Description
P0603128 / P0603131	TSM LAQ line-alarm NON-CHARGING
P0603130 / P0603133	TSM LAQ line-alarm Apple MFi certified
P0603144 / P0603145	TSM LAQ line-alarm USB Type - C
P0603129 / P0603132	TSM LAQ line-alarm Micro USB

TSS (line-alarm)

Part # (white/black)	Description
P0603122 / P0603125	TSS LAQ line-alarm NON-CHARGING
P0603124 / P0603127	TSS LAQ line-alarm Apple MFi certified
P0603143 / P0603153	TSS LAQ line-alarm USB Type - C
P0603123 / P0603126	TSS LAQ line-alarm Micro USB



TSL (stand-alone)

Part # (white/black)	Description
P0603088 / P0603094	TSL stand-alone NON-CHARGING
P0603090 / P0603096	TSL stand-alone Apple MFi certified
P0603146 / P0603155	TSL stand-alone USB Type - C
P0603089 / P0603095	TSL stand-alone Micro USB

TSL (stand-alone only) PSU

Part #	Description
P0603135	TSL 12V/1A PSU EU
P0603140	TSL 12V/1A PSU UK
P0603136	TSL 12V/1A PSU US
P0600733	TSL 24V 4-arm PSU EU (to power up 4 TSL)
P0600744	TSL 24V 4-arm PSU UK (to power up 4 TSL)
P0600609	TSL 24V 4-arm PSU US (to power up 4 TSL)

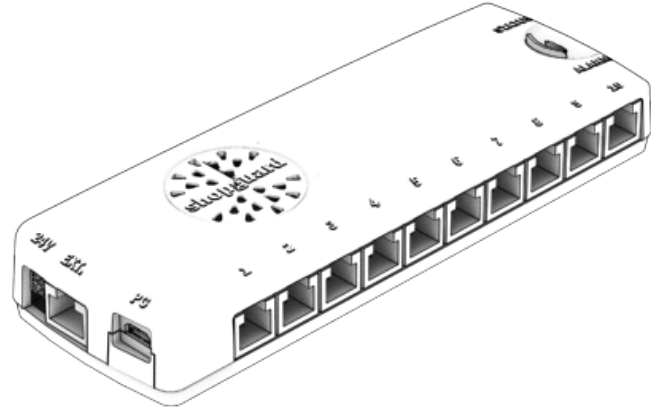
M-10 central unit

Image	Part #	Description
	P0603013	M-10 central unit
	P0603014	M-10 external buzzer

M-4 central unit

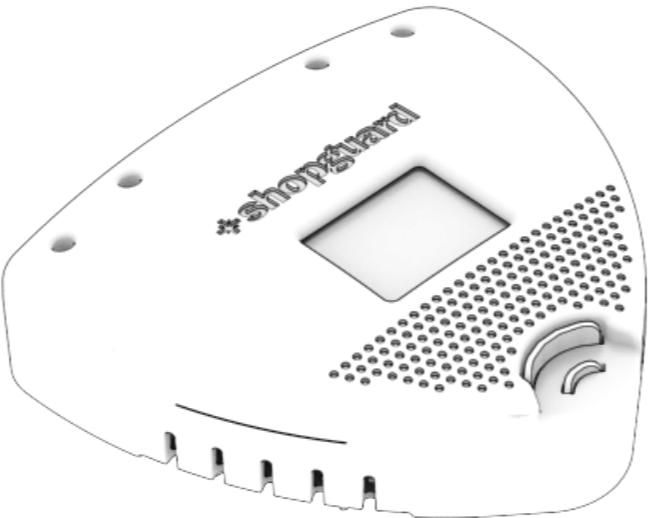
Image	Part #	Description
	P0601569	M-4 central unit 24V

M-10 PSUs

Part #	Description
P0603135 /*40 / *36	12V / 1A PSU (non-charging) EU / UK / US
P0600241 /*242 / *243	24V / 2.5A PSU (max 5 position charging) EU / UK / US
P0603040 /*3168 /*3169	24V / 5A PSU (10 position charging) EU / UK / US

M-10 external reader (and buzzer with illumination)

Part #	Description
P0603028	External reader (1.5m cable length), flush mount, needs drilling
P0603037	External reader (1.5m cable length), tabletop mount



M-4 PSUs

Part #	Description
P0603135 /*40 / *36	12V / 1A PSU (non-charging) EU / UK / US
P0600241 /*242 / *243	24V / 2.5A PSU (4 position charging) EU / UK / US

M-4 external reader

Part #	Description
P0603042	External reader (1m cable length), tabletop mount
P0601230	External reader (1.5m cable length), flush mount, needs drilling
P0600222	External reader (1.5m cable length), tabletop mount

Cradles without TS sensors

Image	Part #	Description
	White P0603007 Black P0603027	TSL LAQ cradle No sensor, only plastic
	White P0603008 Black P0603028	TSM cradle No sensor, only plastic
	White P0603009 Black P0603029	TSS cradle No sensor, only plastic

TS sensors

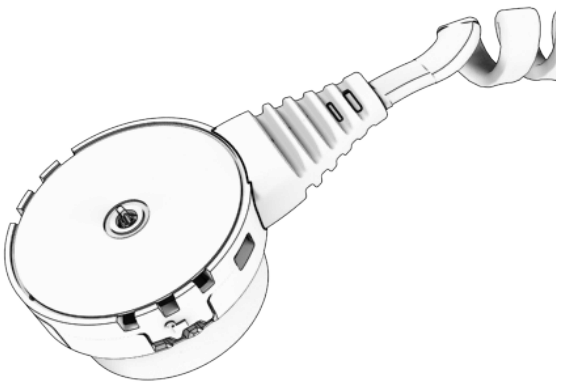
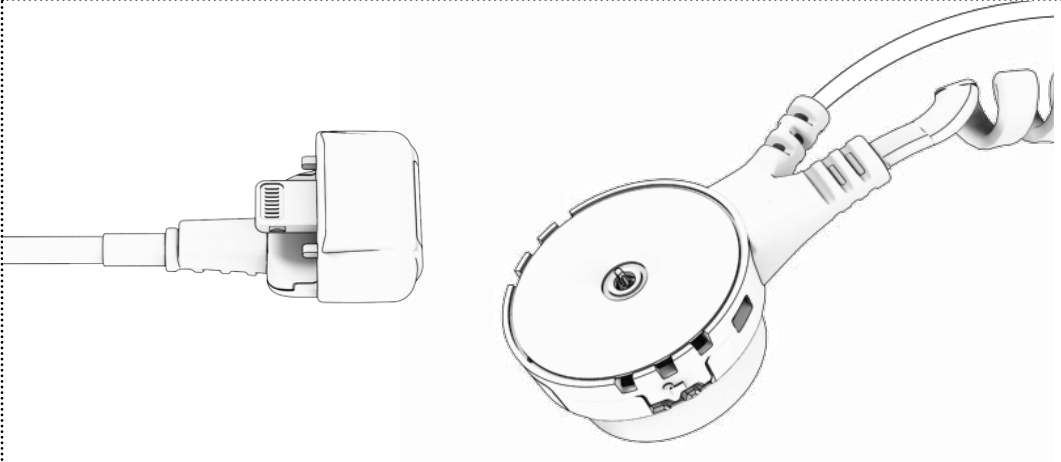
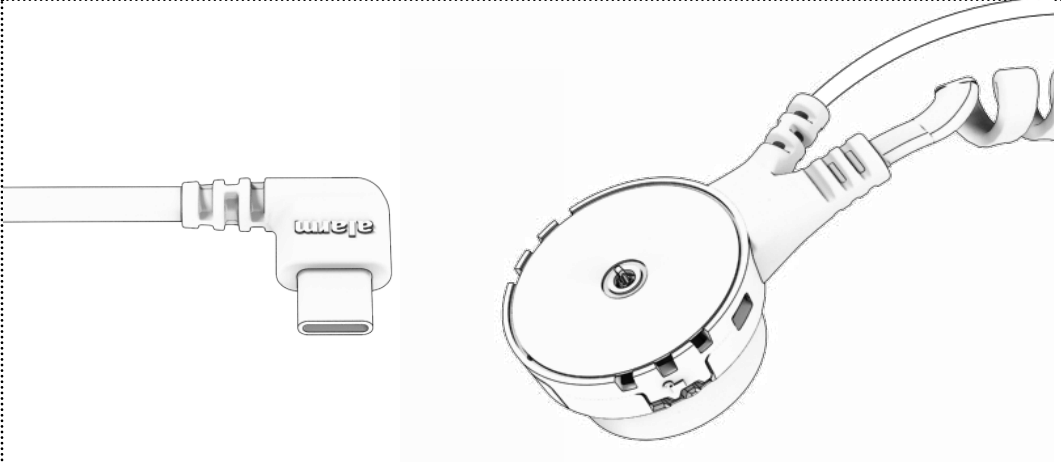
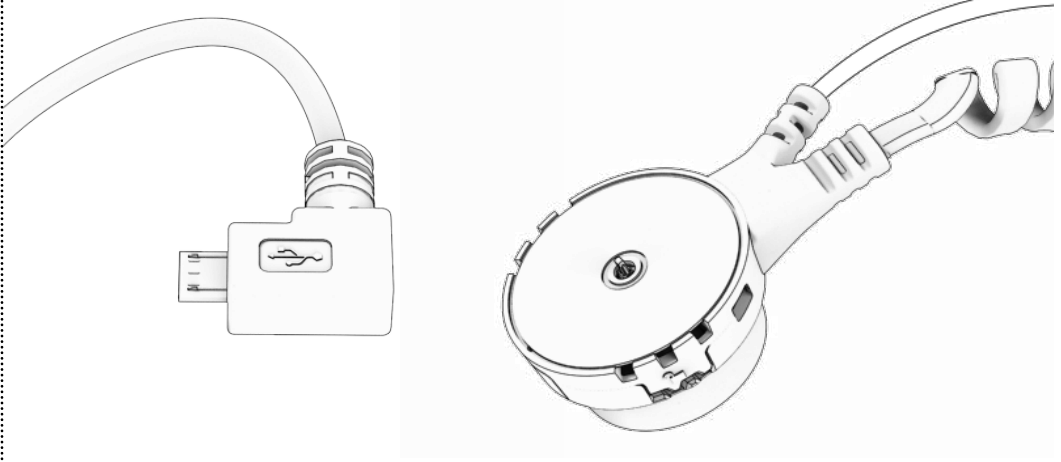
Image	Part #	Description
	White P0603003 Black P0603024	Non-charging TS - sensor with adhesive
	White P0603005 Black P0603026	Apple Lightning MFi certified TS - sensor with adhesive
	White P0603141 Black P0603151	USB Type - C TS - sensor with adhesive
	White P0603001 Black P0603022	Micro USB TS - sensor with adhesive

Adhesives and wipe

Part #	Description
P0620085	TS sensor adhesive
P0620093	TS sensor cable clip adhesive
P0620101	TSS cradle bottom adhesive
P0620101	TSM cradle bottom adhesive
P0620087	TSL cradle bottom adhesive I. (front)
P0620086	TSL cradle bottom adhesive II. (back)
P0620039	M-10 bottom adhesive (2 pcs needed)
P0620028	M-4 bottom adhesive
P0601563	Alcohol wipe

Others

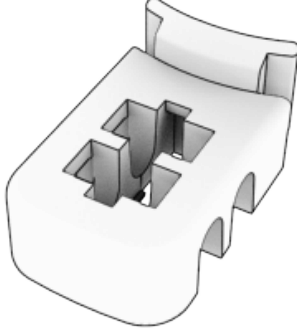
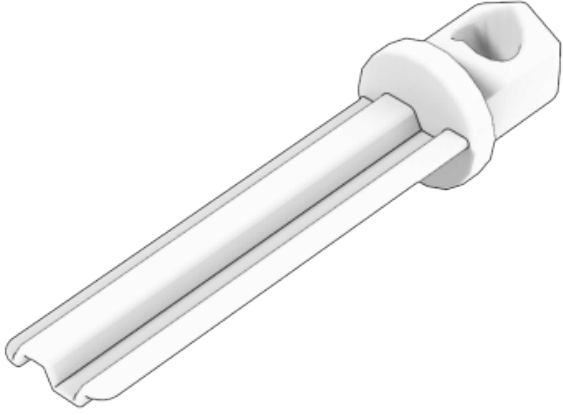
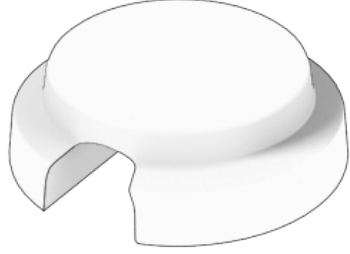
Image	Part #	Description
	P0603061	Claw holder tongue for Easy Family for Smart Base for Smart Recoiler
	P0603019	Wave Key (Lock-down)
	P0623039	Charging lead clip Adhesive included

Technical Data

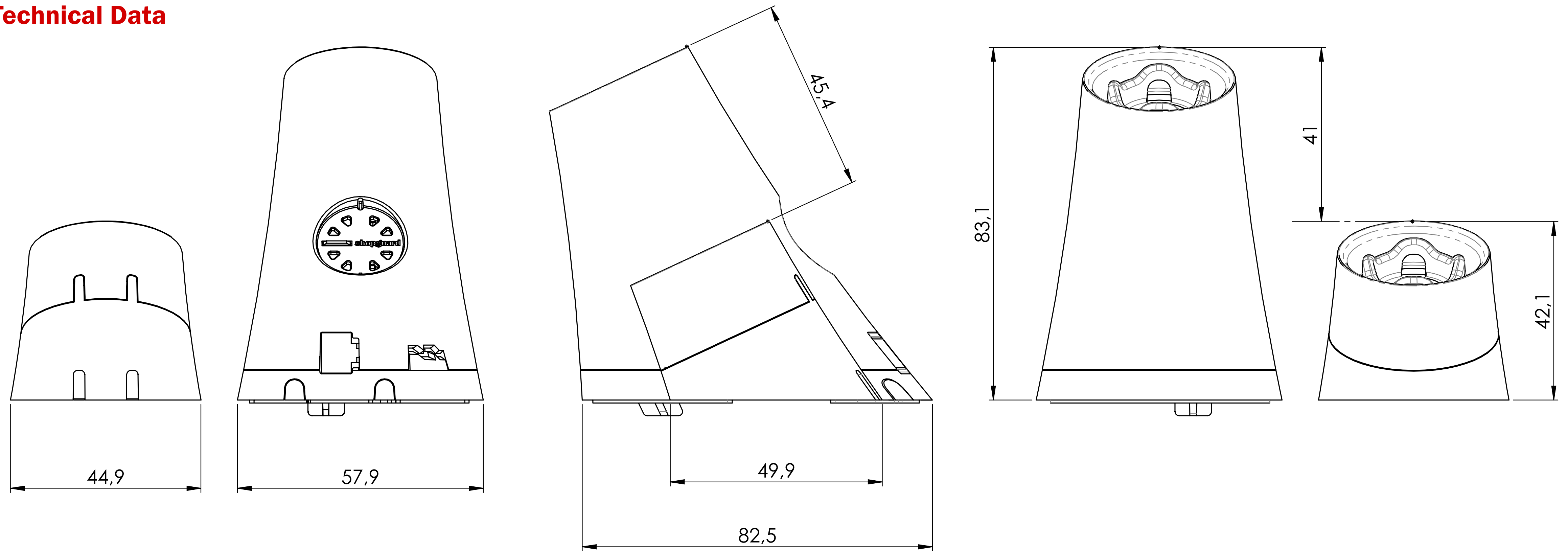

Product Type:

Centralized / Stand-alone (TSL only)

Available Colours

White, MOQ for other colour

Mounting Options

Adhesive or self-tapping screws (TSM, TSS)
or adhesive and threaded rod for TSL

Charging leads

Micro USB, USB Type-C, Apple Lightning

Input

110-240 VAC, 50-60Hz, 1.8A

Output / Charging Capability

24V = 5A (M-10)
5.2V/2A for charging